



Catalog 2020

MOTORCYCLE HANDLING SOLUTIONS

Index

Acebikes is a Dutch company, since 2007 specializing in the design and development of innovative accessories for every type of motorcyclist.

With years of experience in the field of transport of the motorcycle, there are several products arise that facilitate the life of a motorcyclist. Quality, ease of use and constant innovation are key when it comes to Acebikes products. Therefore, we see our products not only as a product, but as a complete solution. Anno 2020 Acebikes is ready for the future, in which we through constant research and user experience respond to the needs of today's motorcyclist. Motorcycle Parking, Transport and Handling Made safe and easy, that is our mission. Deliver products that really helps our users to make the job easy and safe, that is what drives us.



STEADYSTANDS

4	SteadyStand®	10	SteadyStand® Fixed Scooter
6	SteadyStand® Scooter	11	SteadyStand® Multi Fixed
7	SteadyStand® Multi	12	SteadyStand® Cross
8	SteadyStand® Fixed	13	SteadyStand® Cross Basic

TRANSPORT SOLUTIONS

14	TyreFix®	22	Ratchet Kit Scooter
16	TyreFix® Basic	23	Loops set
17	Ratchet Strap Deluxe Duo	24	Flexi Rail - Railset
18	Buckle-Up NEW!	25	D-Ring 4 Pack
20	Cam Buckle Strap Duo	25	D-Ring Heavy-Duty Duo
21	Ratchet Kit Heavy-Duty		

PARKING SOLUTIONS

24	MotorShelter Size M
26	BrakeFix

HANDLING SOLUTIONS

28	Bike-A-Side
31	U-Turn Motor Mover
32	U-Turn Motor Mover XL NEW!

FOLDABLE RAMPS

32	Foldable Ramp
34	Foldable Ramp Carry Bag
35	Foldable Ramp Heavy-Duty with Handle
36	Foldable Ramp Heavy-Duty Extra Width
37	Foldable Ramp Compact NEW!

INFO

40	Technical information
45	Icons explained

SteadyStand ®

With the Acebikes SteadyStand your motorcycle is firmly anchored in seconds.

- ✓ Special rubber feet to prevent sliding
- ✓ Easy to move because of the convenient handle
- ✓ The secure locking system on the front wheel provides maximum stability

↻ Suitable for wheels from 15 to 19 inches

↻ Suitable for tyre widths from 90 to 130 mm



Easy to move!



SteadyStand® Scooter

The Acebikes SteadyStand Scooter was developed specifically for scooters and this makes it suitable for almost any type of scooter.

- ✓ Special rubber feet **to prevent sliding**
- ✓ **Specially designed and engineered** for scooters
- ✓ The secure locking system on the front wheel **provides maximum stability**

Adjustable for tyre sizes from 10 to 13 inches

Adjustable for tyre widths from 80 to 120 mm



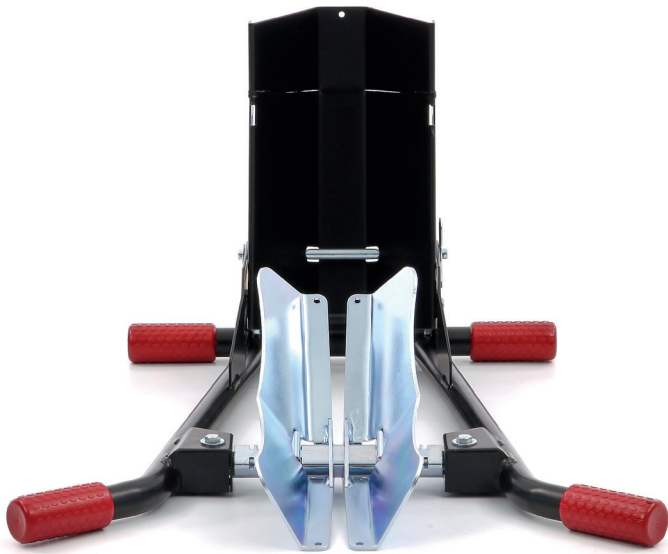

Adjustable
without tools!

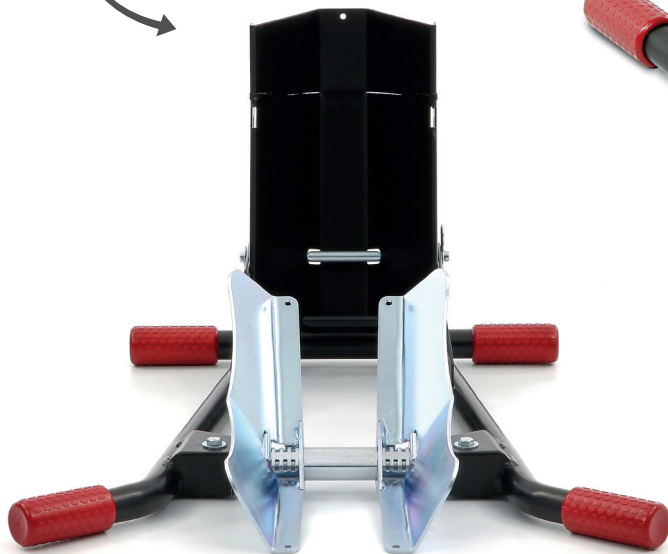

SteadyStand® Multi

With the Acebikes SteadyStand Multi your motorcycle is firmly anchored in seconds.

- ✓ **Completely adjustable** without tools /easy-adjust system
- ✓ The secure locking system on the front wheel **provides maximum stability**
- ✓ **Fully adjustable**, also very suitable for bigger motorbikes

↻ Suitable for wheels from 15 to 21 inches

↻ Suitable for tyre widths from 90 to 200 mm





SteadyStand ® Fixed

The galvanized Acebikes SteadyStand Fixed is designed to make clever use of gravity.

- ✓ Galvanized for **extreme durability**
- ✓ Includes **mounting hardware**
- ✓ The secure locking system on the front wheel **provides maximum stability**

↻ Suitable for wheels from 10 to 19 inches

↻ Suitable for tyre widths from 90 to 130 mm



SteadyStand® Fixed Scooter

The galvanized Acebikes SteadyStand Fixed Scooter is designed to make clever use of gravity.

- ✓ Anchorable **on any hard surface**
- ✓ **Including mounting hardware**
- ✓ The secure locking system on the front wheel **provides maximum stability**

Adjustable for wheels from 10 to 13 inches

Adjustable for tyre widths from 80 to 120 mm





Adjustable
without tools!



SteadyStand® Multi Fixed

The galvanized Acebikes SteadyStand Multi Fixed is designed to make clever use of gravity.

- ✓ **Adjustable without tools** / easy-adjust system
- ✓ **Ideal for using on trailers or in vans**
- ✓ **The secure locking system on the front wheel provides maximum stability**

↻ Suitable for wheels from 15 to 21 inches

↻ Suitable for tyre widths from 90 to 200 mm



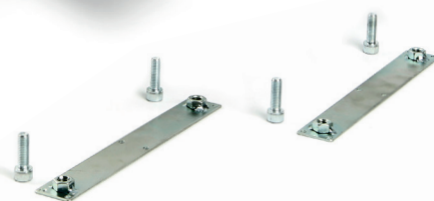

SteadyStand ® Cross

The galvanized Acebikes SteadyStand Cross is especially developed for dirtbikes and enduro bikes.

- ✓ The footpedal is provided with a **special secure lock-system**
- ✓ **Mounting bracket of choice** for small or large cross tyres
- ✓ **Keyholes in the sideframe** for easy removal of the SteadyStand Cross

↻ Suitable for wheels from 18 to 21 inches

↻ Suitable for tyre widths from 90 to 120 mm



Special secure lock-system

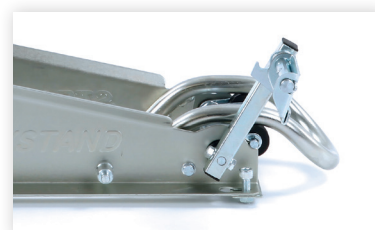

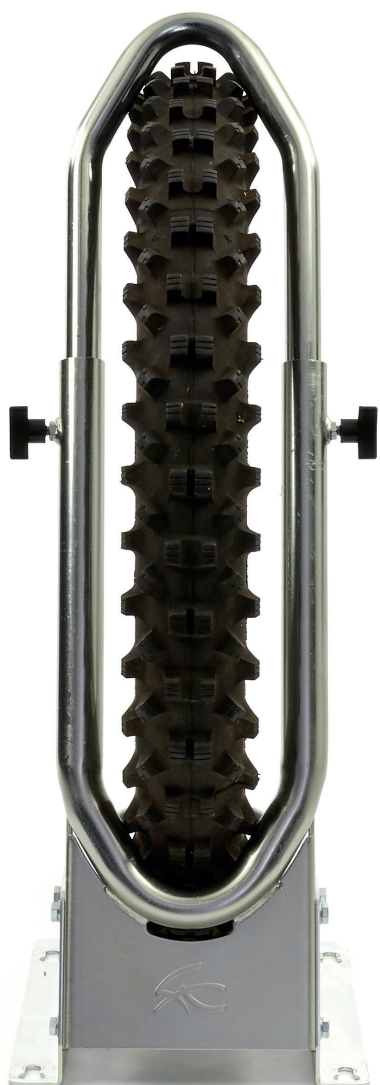



SteadyStand[®] Cross Basic

The galvanized Acebikes SteadyStand Cross basic is especially developed for transporting dirtbikes.

- ✓ Holds the motorbike upright for **easy lashing and securing**
- ✓ Specially developed **for dirtbikes**
- ✓ **Durable galvanized materials**

 Suitable for wheels from 18 to 21 inches

 Suitable for tyre widths from 90 to 120 mm



TyreFix ®

The Acebikes TyreFix is a tie-down set with a special tie-down strap system for securing any type of motorcycle on a trailer, van or transporter.

- ✓ **Special friction material** to prevent moving
- ✓ **Solid carrying case included**, with zipper and carrying handle
- ✓ Including two integrated **high quality lashing straps**

✓ Solid carrying case included

✓ Including two integrated high quality lashing straps





Including two integrated high quality lashing straps!



TyreFix ® Basic

The Acebikes TyreFix Basic is a tie-down set with a special tie-down strap system for securing any type of motorbike on a trailer, van or transporter.

- ✓ **Special friction material** to prevent moving
- ✓ Suitable for **every tyre size**
- ✓ Fully sectioned construction for **easy fitting and removal**

✓ Easy to attach

✓ Durable High Quality materials







Ratchet Strap Deluxe Duo

Practical, extra strong heavy-duty belt made of high-quality polyester with a practical ratchet.

- ✓ **With sewn-in Soft Hook** for easy and safe application
- ✓ **Protects paint and chrome surfaces** with the integrated simulated sheepskin sleeve
- ✓ **Equipped with fully galvanized Heavy-Duty Ratchets**

 Load capacity: 900 daN

 Strap width: 35 mm

 Strap length: 197 cm



With secure locking-clip!





Buckle-Up

The Buckle-up, with its practical straps that are both long and wide, is your essential piece of equipment to make motor handling easy and trouble-free.

- ✓ **All-in one** handlebar tiedown solution
- ✓ Complete set with **fully galvanized 5 cm Cam Buckle**
- ✓ Protects with the integrated simulated **sheepskin sleeve**

↻ Strap width: 35 mm

↻ Strap length: 300 cm



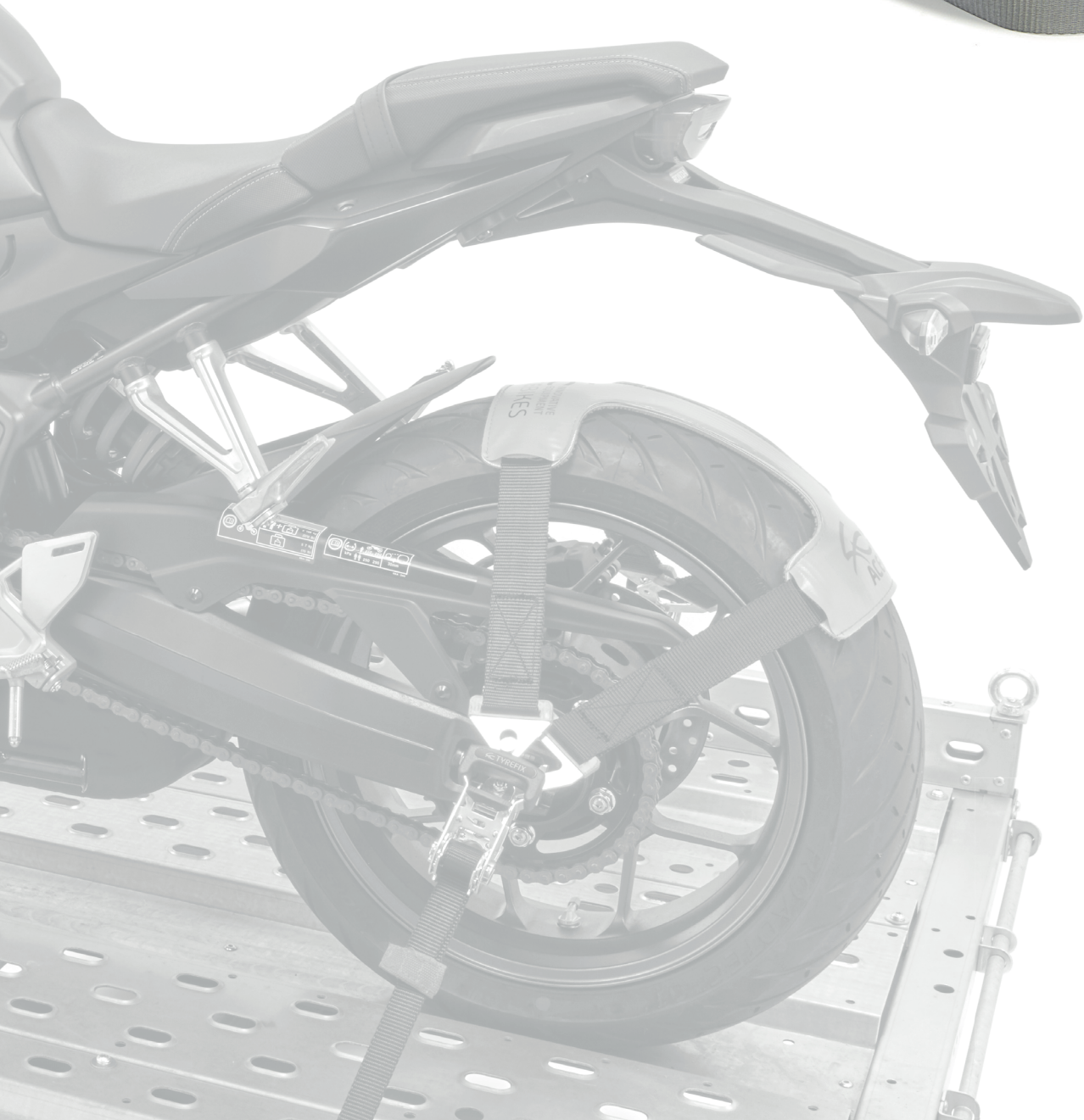

NEW

Cam Buckle Strap Duo

Practical and very strong straps made of high-quality polyester.

- ✓ Durable and **extremely firm material**
- ✓ **Prevents damage** while hooking
- ✓ **Easy to use**
- ✓ Comes with **handy carrying bag**

↻ Lashing capacity: 300 daN

↻ Strap width: 35 mm

↻ Strap length: 180 cm



Ratchet Kit Heavy-Duty

The Acebikes Ratchet Kit Heavy-Duty is perfect for securing any type of motorcycle.

- ✓ **Heavy duty** plasticized hooks
- ✓ **Resilient locking clips** for extra security
- ✓ Comes with **two loops**
- ✓ Comes with **handy carrying bag**

↻ Lashing capacity ratchet 750 daN
Lashing capacity loops 500 daN

↻ Strap width: 25 mm

↻ Strap length: 180 cm



↪ Acebikes Loops Set included!





Ratchet Kit Scooter

With the Ratchet Kit Scooter by Acebikes you can be sure that your beloved scooter gets from A to B safely and securely.

- ✓ With sewn-in Soft Hook for easy and safe application
- ✓ Equipped with 4 x Fully galvanized premium ratchets
- ✓ Comes with solid and handy carrying bag

↻ Lashing capacity: 350 daN

↻ Strap width: 25 mm

↻ Strap length: 180 cm





Loops Set

With the Acebikes Loops Set, you can create a hookpoint anywhere you want, to attach your lashing without risking any kind of damage to your motorbike.

- ✔ Prevents damage while hooking
- ✔ Easy to use
- ✔ Create hookpoints anywhere you want



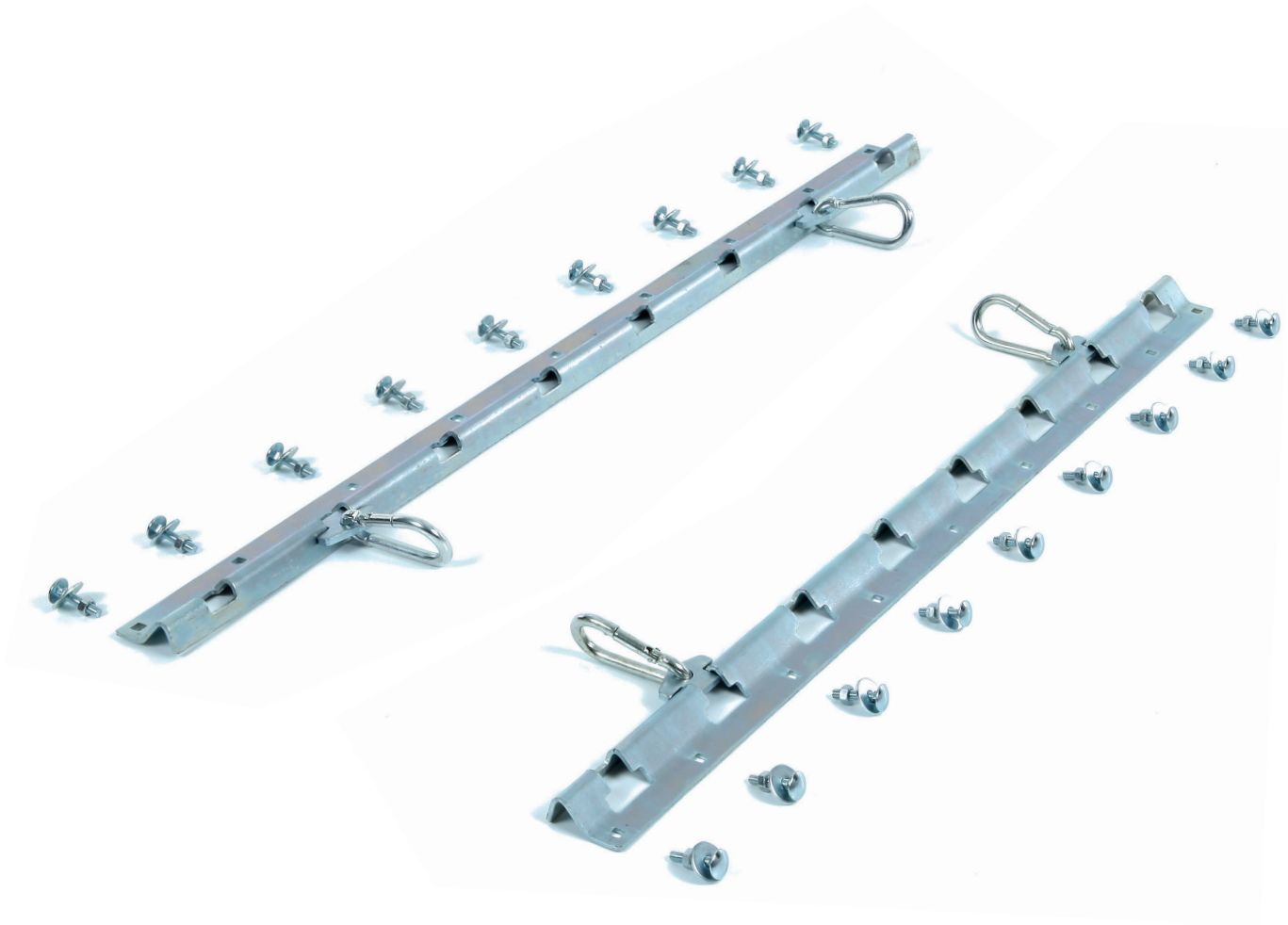

Flexi Rail - Railset

The Acebikes Transport Tie-Down Rail Set secures any type of motorcycle to prevent it from moving during transportation.

- ✓ Fully galvanized steel to **prevent rust**
- ✓ Suitable for **every motorcycle**
- ✓ Can be **secured at different points**





D-Ring 4 Pack

The Acebikes Flexi Hook 4 pack D-ring mounts can be folded flat when not in use.

- ✓ Durable D-Ring tie-downs with high-strength **steel construction for strength and durability.**
- ✓ Made of zinc-plated solid steel, to **prevent corrosion and rust.**
- ✓ Can be mounted on any hard surface or floor **for increased flexibility**



D-Ring Heavy-Duty Duo

The Acebikes Tie-Down Heavy-Duty D-rings mounting plate may be folded flat when not in use.

- ✓ Made of **exceptionally heavy-duty zinc-plated solid steel**, to prevent corrosion and rust
- ✓ Can be mounted on any hard surface or floor **for increased flexibility**
- ✓ Heavy-Duty workload capacity for **safe and secure heavy motorcycle lashing and transport**



MotorShelter Size M

The Acebikes Shelter Folding Garage is a perfect solution for motorcycle owners with no garage.

- ✓ Fully galvanized groundparts, to prevent rust
- ✓ Including mounting hardware and solid security straps
- ✓ Air vents on both sides to prevent moisture

Inside measurements
(LxWxH) 302 x 119 x 170 cm





Air vents on both sides!



BrakeFix

The brake lever jammer BrakeFix is used to lock the front brake for any type of motorcycle.

- ✓ Special click to lock system
- ✓ Suitable for **every** motorcycle
- ✓ Adjustable into **different** positions

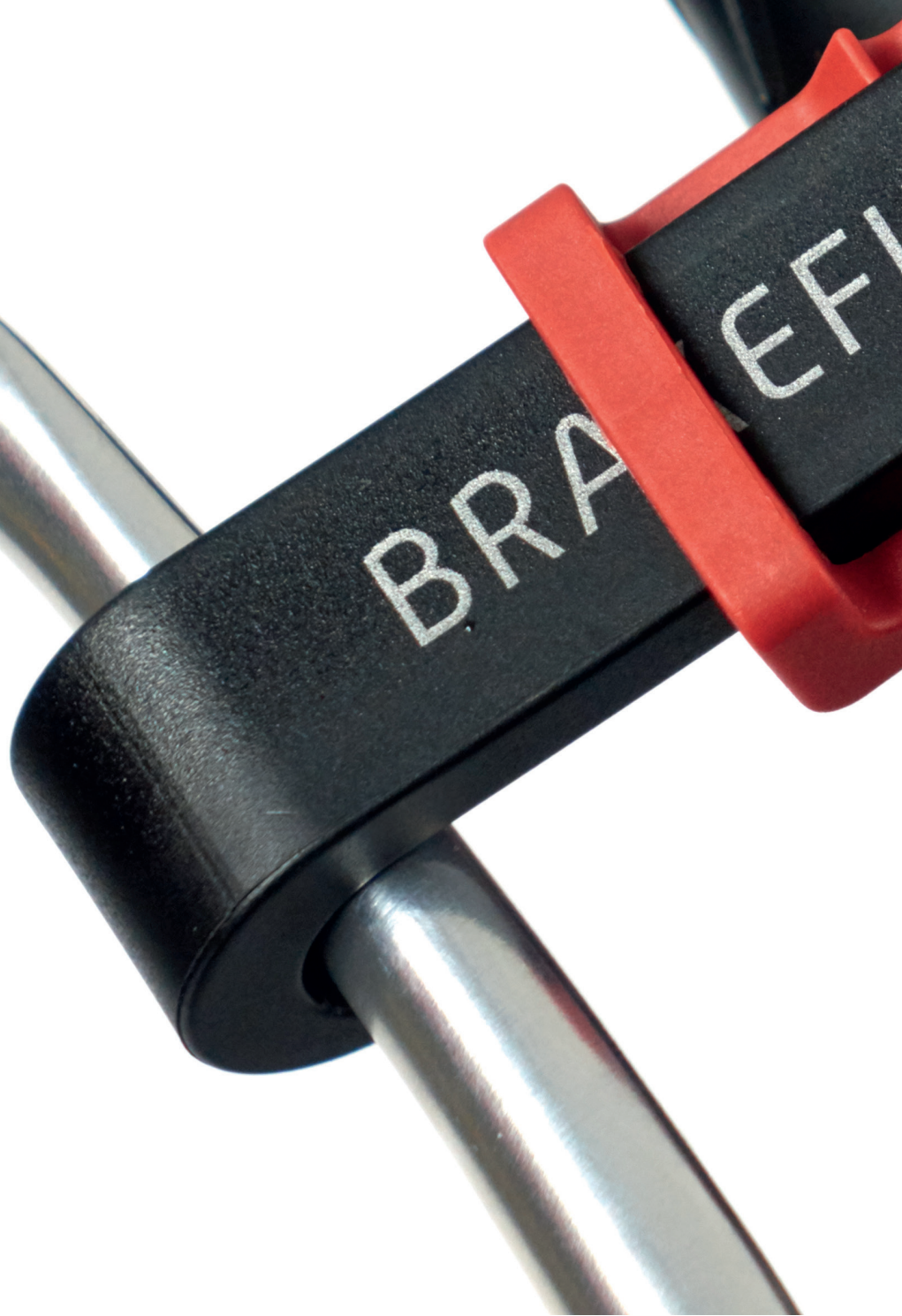







Bike-A-Side

The Acebikes Bike-a-Side Motorcycle Dolly is the perfect solution for maneuvering motorcycles with center stands.

- ✓ Easily lift and move your motorcycle
- ✓ Light and controlled lifting and lowering with the convenient handle
- ✓ Perfect for use on uneven surfaces
- ✓ High-friction bottom side for easy and save braking

Heavy-Duty 4 x 65 mm Ball Bearing swivel wheels

Lifts motorcycles up to 450 kg



U-Turn Motor Mover

The Acebikes U-Turn Motor Mover helps you to easily lift and move your motorcycle.

- ✓ Easily lift and move your motorcycle
- ✓ Perfect for use in narrow spaces
- ✓ Foldable for easy storage
- ✓ Adjustable without tools

High quality 4 x 75 mm swivel wheels



U-Turn Motor Mover XL

Lifting and moving your motorcycle has just become a piece of cake. The only thing you need to do is to place the U-TURN Motor Mover XL in the required position without tools and lift your motorcycle onto it.

- ✔ Perfect for use in **narrow spaces**
- ✔ **Easily lift and move** your motorcycle
- ✔ Suitable for motorcycles weighing **up to 450 kg**
- ✔ Adjustable **without tools**

Product size unfolded
[LxWxH]: 255 x 73 x 15 cm

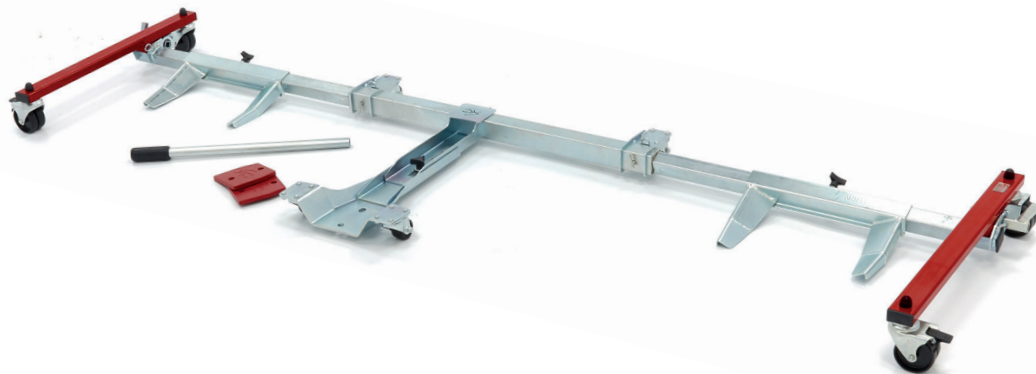

NEW

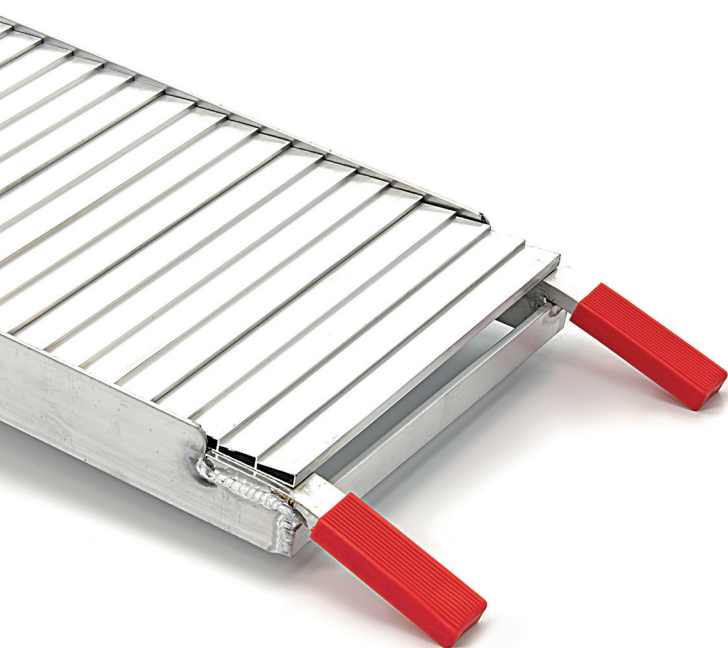

Plastic parts
to
prevent scratching!



Foldable Ramp

This Acebikes Foldable Ramp is an extremely sturdy and firm ramp, made of high quality aluminium for loading motorcycles onto a trailer, van or transporter.

- ✓ Light weight
- ✓ Special plastic parts to prevent scratches and damage to your vehicle
- ✓ Including a tension strap to secure the Loading Ramp during use

↻ Suitable for motorbikes up to 340 kg

↻ Ramp width: 28 cm





Foldable Ramp Carry bag

Your Foldable Ramp can be stored as well as transported safely and securely in this superior quality Foldable Ramp Carry bag.

- ✓ **Optimal storage and transportation** for your Loading Ramp
- ✓ **Specially designed** for most types of Foldable Ramps
- ✓ **High quality fabric** for perfect usage

Measurements:
120 x 17 x 32 cm



Foldable Ramp

Heavy-Duty with Handle

This premium quality ramp has all the required specifications that will allow you to store your motorbike safely and securely.

- ✓ Fully closed surface for **extra grip and durability**
- ✓ **Superior Heavy-Duty all-aluminum** yet lightweight construction
- ✓ Equipped with **easy to use handle** for easy handling and storage

↻ Suitable for motorbikes up to 680 kg

↻ Ramp width: 28,5 cm

↻ Net weight: 12 kg



Foldable Ramp

Heavy-Duty Extra Width

This premium quality ramp has all the required specifications that will allow you to store your motorbike safely and securely.

- ✓ **Superior Heavy-Duty all-aluminum** yet lightweight construction
- ✓ **Equipped with easy to use handle** for easy handling and storage
- ✓ **Extra width construction** for easy loading and unloading

↻ Suitable for all motorbikes up to 500 kg

↻ Ramp width: 57 cm





Foldable Ramp Compact

Are you looking for a good solution to load your motorbike or Scooter onto a trailer, van, or transporter? The Acebikes Foldable Ramp Compact is up to the task.

- ✓ **Space saving folding design** for compact storage
- ✓ Strong yet **lightweight aluminum**
- ✓ Comes with **practical carry bag**

↻ Suitable for all motorbikes up to 300 kg

↻ Ramp width: 25 cm



NEW

SteadyStand®



Article Information

Product number:
5009
Model description:
SteadyStand®
Color:
Black
Accessories:
Wheel strap

Adjustability information

Tyre inches:
15" to 19"
Tyre width:
90 mm to 130 mm

Technical information

Material:
Steel
Material processing:
Powdercoated
Net weight:
7 kg
Product size (LxWxH):
61 x 52 x 35 cm

SteadyStand® Scooter



Article Information

Product number:
8080
Model description:
SteadyStand® Scooter
Color:
Grey
Accessories:
Wheel strap

Adjustability information

Tyre inches:
10" to 13"
Tyre width:
80 mm to 120 mm

Technical information

Material:
Steel
Material processing:
Powdercoated
Net weight:
5 kg
Product size (LxWxH):
49 x 47 x 29 cm

SteadyStand® Multi



Article Information

Product number:
5003
Model description:
SteadyStand® Multi
Color:
Black
Accessories:
Wheel strap

Adjustability information

Tyre inches:
15" to 21"
Tyre width:
90 mm to 200 mm

Technical information

Material:
Steel
Material processing:
Powdercoated
Net weight:
10 kg
Product size (LxWxH):
70 x 61 x 38 cm

SteadyStand® Fixed



Article Information

Product number:
5002
Model description:
SteadyStand® Fixed
Color:
Zinc
Accessories:
Mounting hardware

Adjustability information

Tyre inches:
10" to 19"
Tyre width:
90 mm to 130 mm

Technical information

Material:
Steel
Material processing:
Galvanized
Net weight:
5 kg
Product size (LxWxH):
62 x 21 x 38 cm

SteadyStand® Fixed Scooter



Article Information

Product number:
6006
Model description:
SteadyStand® Fixed
Scooter
Color:
Zinc

Accessories:
Mounting hardware

Adjustability information

Tyre inches:
10" to 13"
Tyre width:
80 mm to 120 mm

Technical information

Material:
Steel
Material processing:
Galvanized
Net weight:
3,4 kg
Product size (LxWxH):
50 x 19 x 30,5 cm

SteadyStand® Multi Fixed



Article Information

Product number:
5004
Model description:
SteadyStand®
Multi Fixed
Color:
Zinc

Accessories:
Wheel strap,
Mounting hardware

Adjustability information

Tyre inches:
15" to 21"
Tyre width:
90 mm to 200 mm

Technical information

Material:
Steel
Material processing:
Galvanized
Net weight:
8 kg
Product size (LxWxH):
65,5 x 28 x 38 cm

SteadyStand®
Cross



Article Information
Product number:
5005
Model description:
SteadyStand® Cross
Color:
Zinc
Accessories:
Mounting hardware

Adjustability information
Tyre inches:
18" to 21"
Tyre width:
90 mm to 120 mm

Technical information
Material:
Steel
Material processing:
Galvanized
Net weight:
10 kg
Product size (LxWxH):
60 x 37 x 75 cm

SteadyStand®
Cross Basic



Article Information
Product number:
8068
Model description:
SteadyStand® Cross
Basic
Color:
Zinc

Accessories:
Mounting hardware

Adjustability information
Tyre inches:
18" to 21"
Tyre width:
90 mm to 120 mm

Technical information
Material:
Steel
Material processing:
Galvanized
Net weight:
8 kg
Product size (LxWxH):
54 x 25 x 75 cm

Tyrefix®



Article Information
Product number:
5006
Model description:
TyreFix
Color:
Grey
Accessories:
Solid carrying case

Capacity
Lashing capacity:
500 daN

Technical information
Material:
Polyester
Straps length:
65 cm
Net weight:
2,1 kg

Carrying case size (LxWxH):
40 x 23 x 6 cm

Tyrefix®
Basic



Article Information
Product number:
6008
Model description:
TyreFix Basic
Color:
Grey

Capacity
Lashing capacity:
500 daN

Technical information
Strap Material:
Polyester
Net weight:
1 kg

Ratchet Strap
Deluxe Duo



Article Information
Product number:
8076
Model description:
Ratchet Strap Deluxe
Duo
Color:
Black/Grey

Accessories:
Storage bag
Capacity
Lashing capacity ratchet:
900 daN

Technical information
Material:
Polyester
Material processing:
Galvanized
Net weight:
2,4 kg

Straps length:
197 cm
Straps width:
35 mm
Storage bag size (LxWxH):
26 x 8 x 20 cm

Ratchet Kit
Heavy-Duty



Article Information
Product number:
8065
Model description:
Ratchet Kit Heavy-Duty
Color:
Black
Accessories:
Storage bag, 2x loops

Capacity
Lashing capacity ratchet:
750 daN
Lashing capacity loops:
500 daN

Technical information
Material processing:
Galvanized
Net weight:
1,95 kg
Straps length:
180 cm

Straps width:
25 mm
Storage bag size (LxWxH):
18 x 8 x 17 cm

NEW
Buckle-Up



Article Information
Product number: 8090
Model description: Buckle-up
Color: Black/Grey/Red
Accessories: Storage bag

Capacity
Lashing capacity ratchet: 300 daN

Technical information
Material: Polyester
Material processing: Galvanized
Net weight: 1 kg
Straps length: 300 cm

Straps width: 35 mm
Storage bag size (LxWxH): 24 x 9 x 15 cm

Cam Buckle Strap Duo



Article Information
Product number: 8075
Model description: Cam Buckle Strap Duo
Color: Black/Grey
Accessories: Storage bag

Capacity
Lashing capacity ratchet: 300 daN

Technical information
Material: Polyester
Material processing: Galvanized
Net weight: 1.15 kg
Straps length: 180 cm

Straps width: 35 mm
Storage bag size (LxWxH): 18 x 8 x 17 cm

Ratchet Kit Scooter



Article Information
Product number: 8081
Model description: Ratchet Kit Scooter
Color: Black/Grey
Accessories: Storage bag

Capacity
Lashing capacity ratchet: 350 daN

Technical information
Material: Polyester
Material processing: Galvanized
Net weight: 2 kg

Straps length: 180 cm
Straps width: 25 mm
Storage bag size (LxWxH): 16 x 13 x 19 cm

Loops Set



Article Information
Product number: 8061
Model description: Loops set
Color: Black

Capacity
Lashing capacity: 500 daN

Technical information
Material: Polypropene
Net weight: 0,04 kg
Straps length: 47 cm
Straps width: 2,5 cm

Flexi Rail Railset



Article Information
Product number: 5007
Model description: Flexi Rail - Railset
Color: Zinc
Accessories: Mounting hardware

Technical information
Material: Steel
Material processing: Galvanized
Net weight: 2,7 kg
Product size (LxWxH): 78,5 x 5 x 1 cm

D-Ring 4 Pack



Article Information
Product number: 8077
Model description: D-Ring 4 Pack
Color: Zinc

Accessories: 8 x Lock nuts and hex head bolts (M6 x 25 mm)

Capacity
Assembly Break Strength: 550 kg

Technical information
Material: Steel
Material processing: Galvanized
Net weight p.p.: 0,05 kg
Product size (LxWxH): 7 x 4 x 1 cm

D-Ring Heavy-Duty Duo



Article Information

Product number: 8078
Model description: D-Ring Heavy-Duty Duo
Color: Zinc

Accessories: 4 x Lock nuts and carriage bolts (M10 x 40 mm)

Capacity

Assembly break Strength: 2250 kg

Technical information

Material: Steel
Material processing: Galvanized
Net weight p.p.: 0,1 kg
Product size (LxWxH): 10 x 6 x 1.8 cm

MotorShelter Size M



Article Information

Product number: 8066
Model description: MotorShelter Size M
Color: Grey

Accessories: 4 x security straps, mounting hardware

Technical information

Material: Steel
Material cloth: Polyester
Material processing: Powdercoated

Net weight: 23,5 kg
Product size (LxWxH): 302 x 119 x 170 cm

BrakeFix



Article Information

Product number: 5008
Model description: BrakeFix
Color: Red, Black

Technical information

Material: Plastic
Net weight: 0,054 kg
Product size (LxWxH): 10 x 8 x 3 cm

Bike-A-Side



Article Information

Product number: 6000
Model description: Bike-A-Side
Color: Red, Zinc
Accessories: Position Memory Pad

Capacity Max. payload: 450 kg

Technical information

Material: Steel
Material processing: Galvanized
Net weight: 16,5 kg

Product size (LxWxH): 49 x 85 x 10 cm

U-Turn Motor Mover



Article Information

Product number: 5010
Model description: U-Turn Motor Mover
Color: Red, Zinc

Capacity Max. payload: 275 kg
Max. motorcycle length: 210 cm
Max. motorcycle wheelbase: 130 to 152,5 cm

Technical information

Material: Steel
Material processing: Galvanized
Net weight: 19 kg
Product size folded: 102 x 42 x 84 cm

Product size unfolded: 222 x 23 x 63 cm

NEW

U-Turn Motor Mover XL



Article Information

Product number: 5013
Model description: U-Turn XL Motor Mover
Color: Red, Zinc

Capacity Max. payload: 450 kg
Max. motorcycle length: 250 cm
Max. motorcycle wheelbase: 125,5 to 180 cm

Technical information

Material: Steel
Material processing: Galvanized
Net weight: 27 kg
Product size unfolded: 255 x 73 x 15 cm

Foldable Ramp



Article Information

Product number:
8071
Model description:
Foldable Ramp
Color:
Aluminum
Accessories:
Security strap

Capacity

Max. payload:
340 kg

Technical information

Material:
Aluminum
Net weight:
7,3 kg
Product length folded:
114 cm

Product length unfolded:
220 cm
Height folded:
14,5 cm
Product width:
28 cm

Foldable Ramp Carry Bag

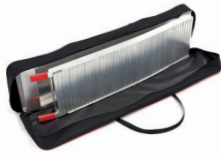

Article Information

Product number:
8073
Model description:
Foldable Ramp Carry Bag
Color:
Black/Red

Technical information

Material:
Textile
Net weight:
0,66 kg
Measurements [LxWxH]:
120 x 17 x 32 cm

Foldable Ramp Heavy-Duty with Handle



Article Information

Product number:
8074
Model description:
Foldable Ramp Heavy-Duty with Handle
Color:
Aluminum

Accessories:
Carry Handle/
Security strap

Capacity

Max. payload:
680 kg

Technical information

Material:
Aluminum
Net weight:
12 kg
Product length folded:
114 cm

Product length unfolded:
223 cm
Height folded:
14,5 cm
Product width:
28,5 cm

Foldable Ramp Heavy-Duty Extra Width



Article information

Product number:
8072
Model description:
Foldable Ramp Heavy-Duty Extra Width
Color:
Aluminum

Accessories:
Carry Handle/Security strap

Capacity

Max. payload:
500 Kg

Technical information

Material:
Aluminum
Net weight:
16,5 Kg
Product length folded:
114 cm

Product length unfolded:
224 cm
Height folded:
14,5 cm
Product width:
57 cm

Foldable Ramp Compact



Article information

Product number:
8082
Model description:
Foldable Ramp Compact
Color:
Aluminum

Accessories:
Security strap

Capacity

Max. payload:
300 Kg

Technical information

Material:
Aluminum
Net weight:
8,6 Kg
Product length folded:
72 cm

Product Length unfolded:
199,2 cm
Product width:
25 cm
Product height folded:
21,5 cm

Icon's explained



This product is easy to carry



This product is made for easy manouvering



This product is made for save and secure motorcycle transport, parking and handling



This product is extremely suitable for motorcycle transport



This product is specially made for Heavy-Duty workload



This product is extremely suitable for motorcycle parking



This product is made for parking on steep slopes



This product is adjustable without any tools



This product is made for covered motorcycle parking

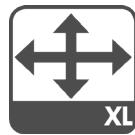

This product is suitable for large and heavy motorcycles

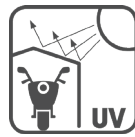

This product is UV resistant



This product is water resistant

What defines us

- ✓ Innovative design
- ✓ High quality materials
- ✓ User-friendly products
- ✓ Clever solutions
- ✓ In-house design and development
- ✓ Experienced experts

Full stock

Fast delivery

Short lines of communication

Flexible approach

Tailormade solutions





For a full Acebikes products experience, visit our website:

www.acebikes.com



INNOVATIVE
EQUIPMENT
ACEBIKES

INNOVATIVE
EQUIPMENT
ACEBIKES